

Digital Ports

Embedded Software

Wolfgang Neff

Assignment 1

- Controlling the internal LED
 - Please let the internal blue LED of your micro-controller blink.

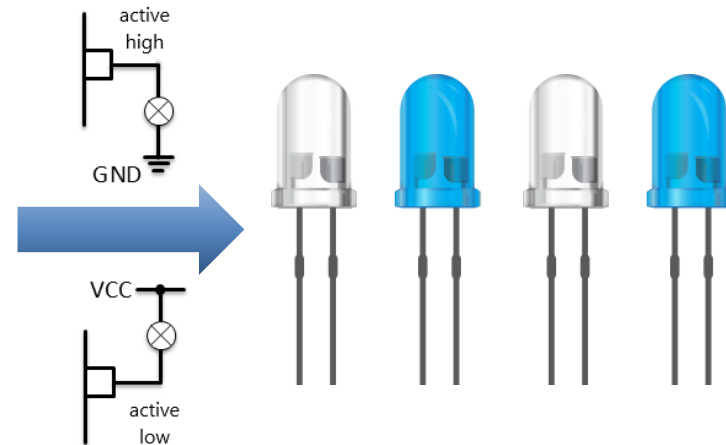
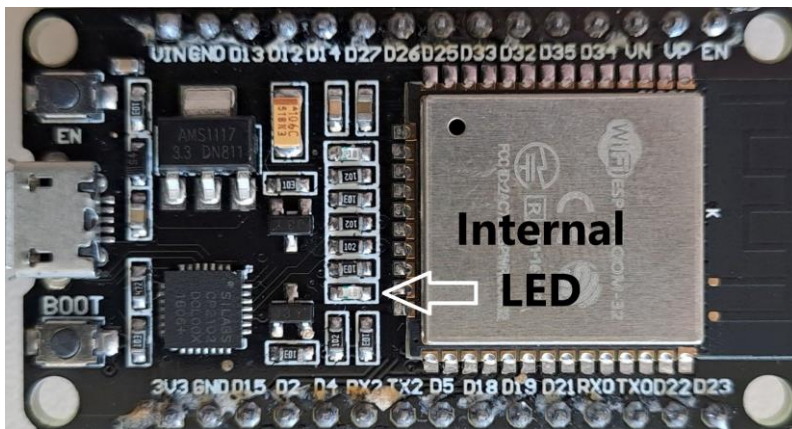

Assignment 2

- Controlling an external LED
 - Please let the green LED of the Color Click blink.

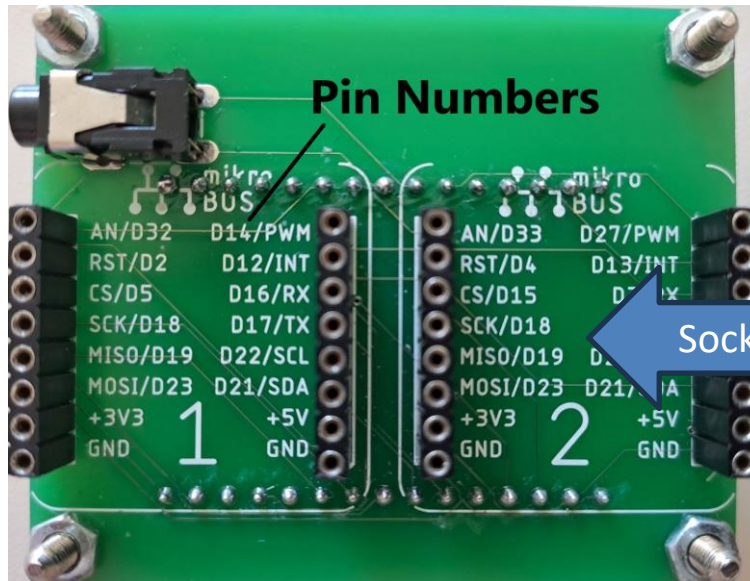

Assignment 3

- Controlling several LEDs
 - Please let the LEDs of the Color Click blink as follows:
 - The red LED blinks ten times with a frequency of 0.5 Hz.
 - The blue LED blinks 15 times with a frequency of 2 HZ.
 - The process starts again.
 - The green LED does not glow.

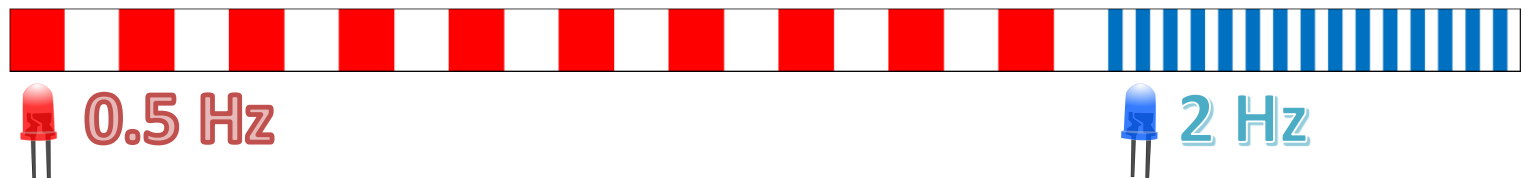

Assignment 4

- Dimming a LED
 - Please dim the intensity of the red LED to 10%.
 - Do not consult the Internet. Think about it on the strength of what you learned so far.

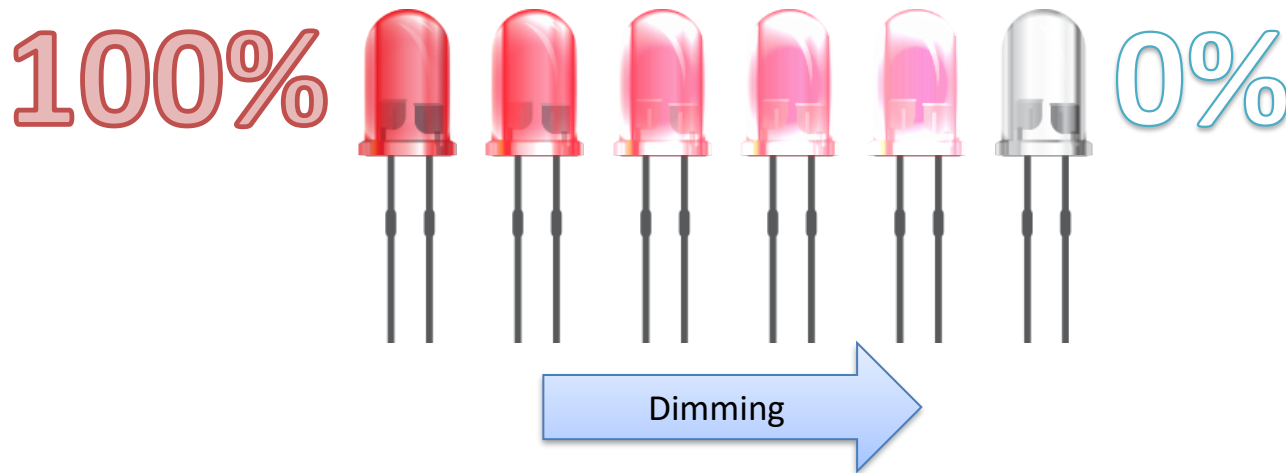

Assignment 5

- Controlling LEDs by means of push buttons
 - Please control the LEDs of the Color-Clicks by means of the 2x2 Key Click as follows:
 - The red LED glows while T1 is pressed.
 - The blue LED glows while T2 is pressed.
 - The green LED glows while T3 is pressed.

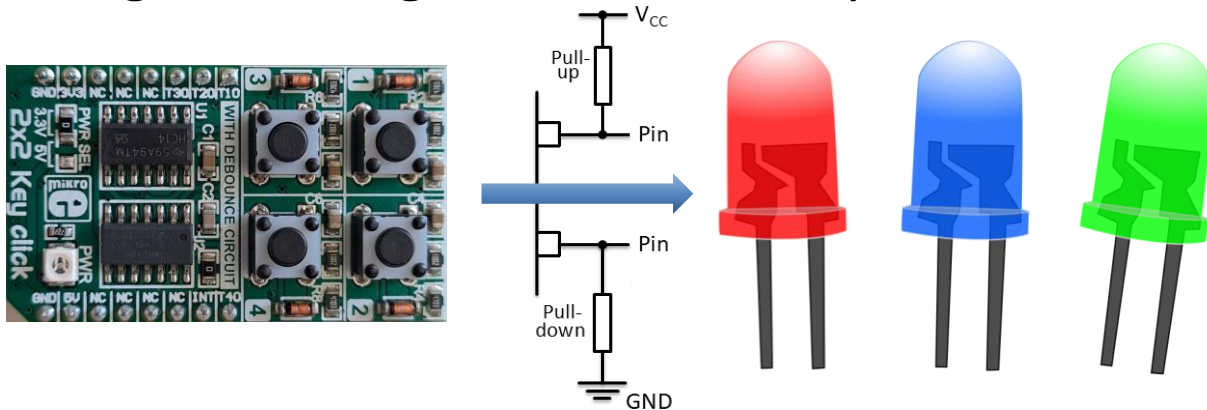

Assignment 6

- Selecting a LED by means of a push button
 - Please control the LEDs of the Color-Clicks by means of the 2x2 Key Click as follows:
 - T1 selects the red LED.
 - T2 selects the green LED.
 - T3 switches the **selected** LED on.
 - T4 switches the **selected** LED off.

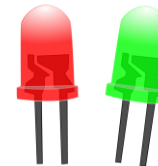
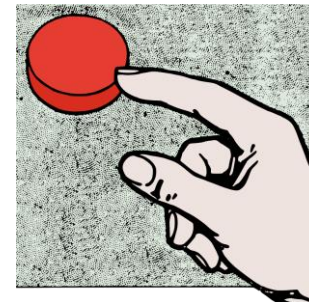

Assignment 7

- Using a push button as switch
 - Please control the LEDs of the Color-Clicks by means of the 2x2 Key Click as follows:
 - T1 selects the red LED.
 - T2 selects the green LED.
 - T3 selects the blue LED.
 - T4 switches the **selected** LED on and off.
 - First press: the selected led gets switched on.
 - Second press: the selected led gets switched off.
 - And so on ...

