

Basic Knowledge

Digital Electronics

Wolfgang Neff

High Voltage Level

- One meaning, so many names
 - + Positive pole, positive terminal
 - +V, V+ Positive voltage
 - 3V3, 5V Voltage specification (e. g. 3.3 V, 5.0 V)
 - V_S Supply voltage
 - VCC Voltage at the collectors (BJT)
 - VDD Voltage at the drains (MOSFET)

Low Voltage Level

- One meaning, so many names
 - - Negative pole, negative terminal
 - -V, V- Negative voltage
 - 0V Voltage specification (0.0 V)
 - GND Ground
 - VSS Voltage at the sources (MOSFET)

Berlin

Frankfurt

München

Wetzlar

Wiesbaden

State of Lines (1)

- A line is high ...
 - ... if there is a direct way to plus.

High ————— ◦ +

- ... if there is a better way to plus.

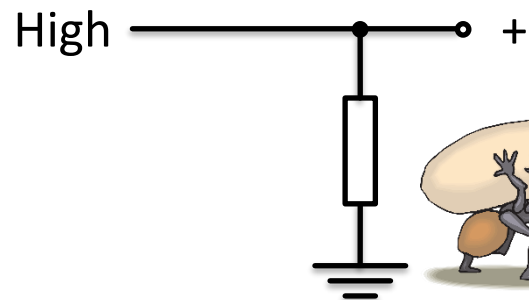

State of Lines (2)

- A line is low ...
 - ... if there is a direct way to minus.



- ... if there is a better way to minus.

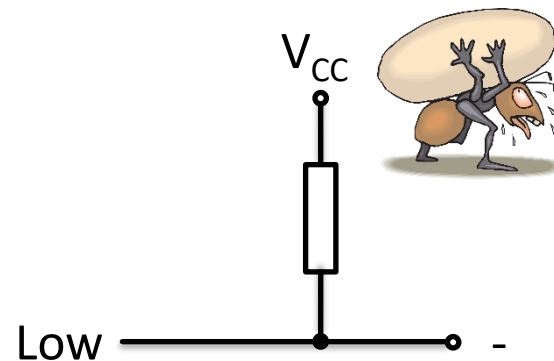

State of Lines (3)

- A line is dangling ...
 - ... if there is no way to either plus or minus.



- Dangling lines in digital circuits are bad.

Active High/Low (1)

- A device can ...
 - ... either be **active high** or **active low** ...
 - ... if it has two states (active or inactive).
 - ... if it can be controlled by a line.
 - This device characteristics can **not** be changed.
- The state of a line ...
 - ... can either be **high** or **low**.
 - ... can **easily** be changed.



Active or
inactive?

High or
low?



Active High/Low (2)

- A device is active high if ...

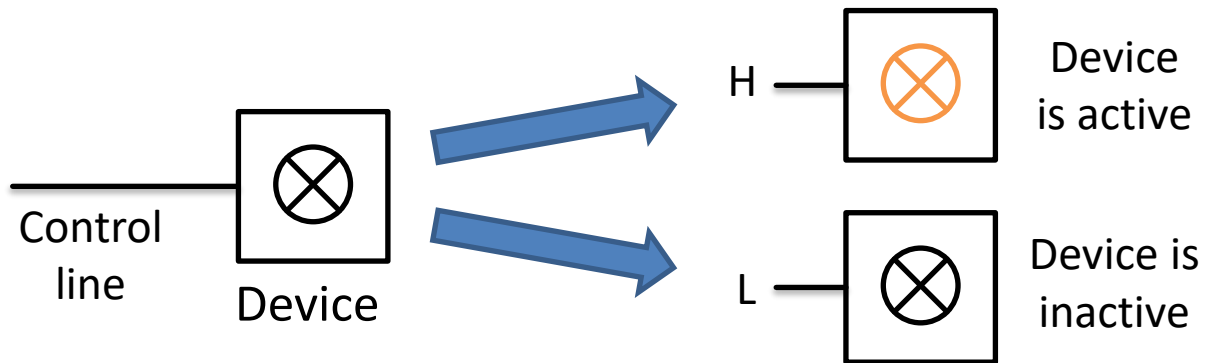

- A device is active low if ...

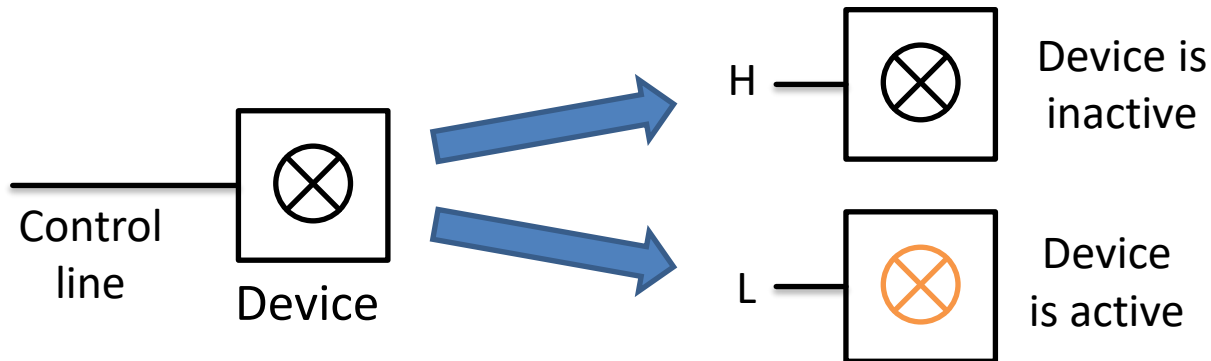

Switches (1)

- Do we come through?
 - It depends ...
 - Yes, if the switch is closed.



- No, if the switch is open.



Switches (2)

- No digital switch without ...
 - ... pull-down resistor.
 - ... pull-up resistor.

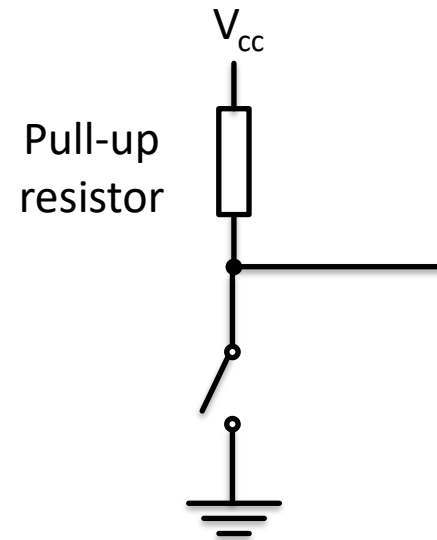
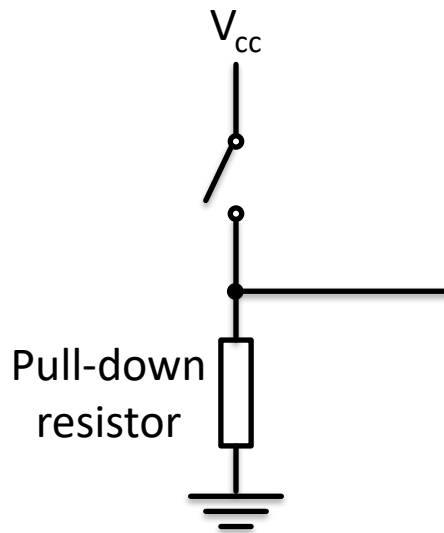

Capacitor

- Do we come through?
 - No way.

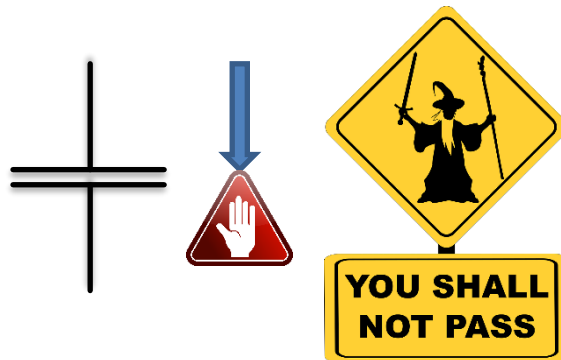

- A capacitor stores current.
- A capacitor can smooth voltages.

Support or
smoothing
capacitor



Diodes (1)

- Do we come through?
 - It depends ...
 - Yes, if its direction is forward.

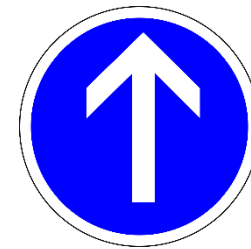
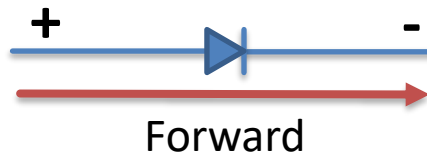

- No, if its direction is reverse.

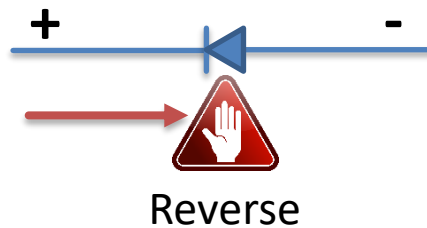

Diodes (2)

- No LED without current limiting resistor

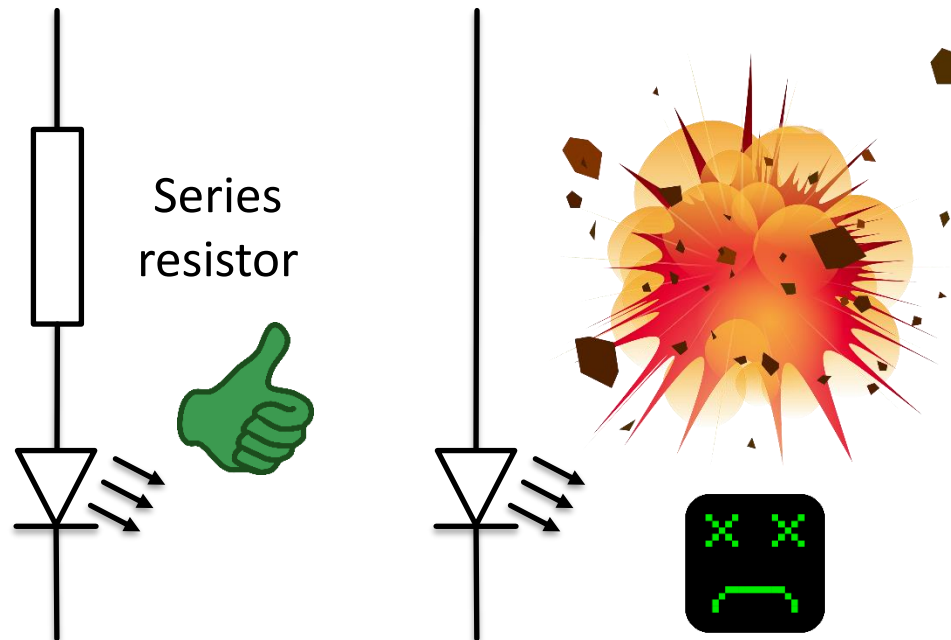

Transistors (1)

- There are two types of transistors

NPN transistor

PNP transistor

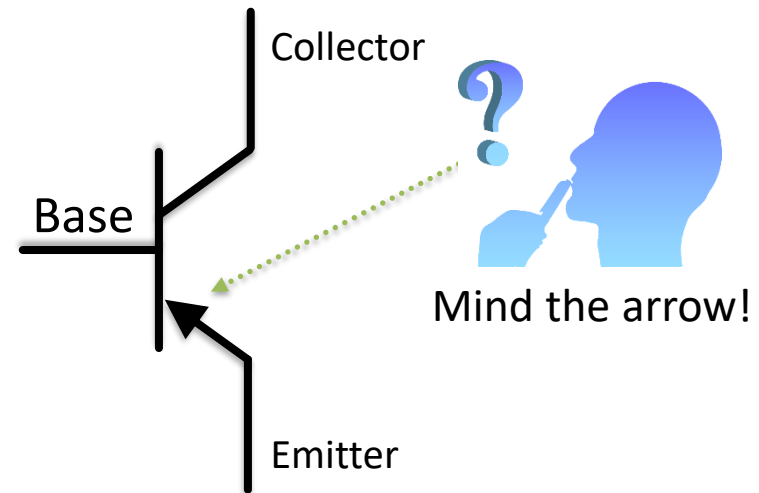
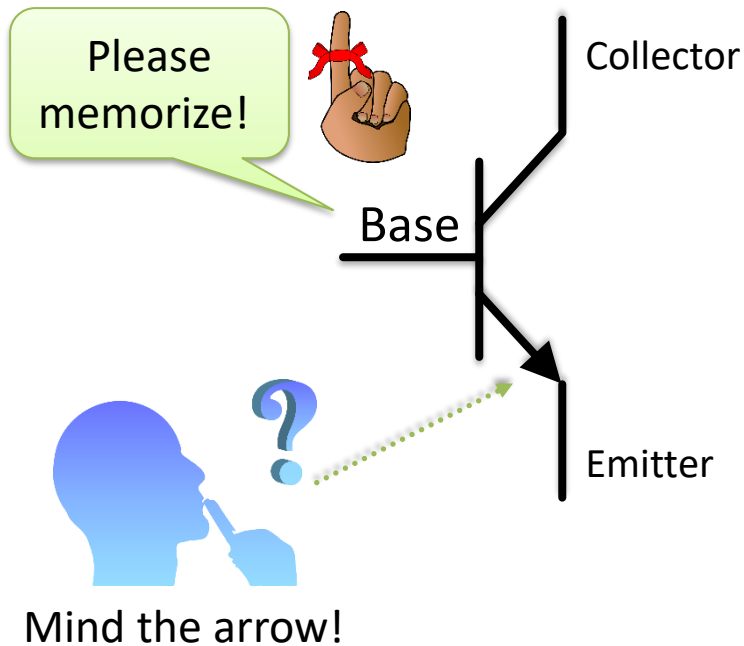

Transistors (2)

- There is a big difference here

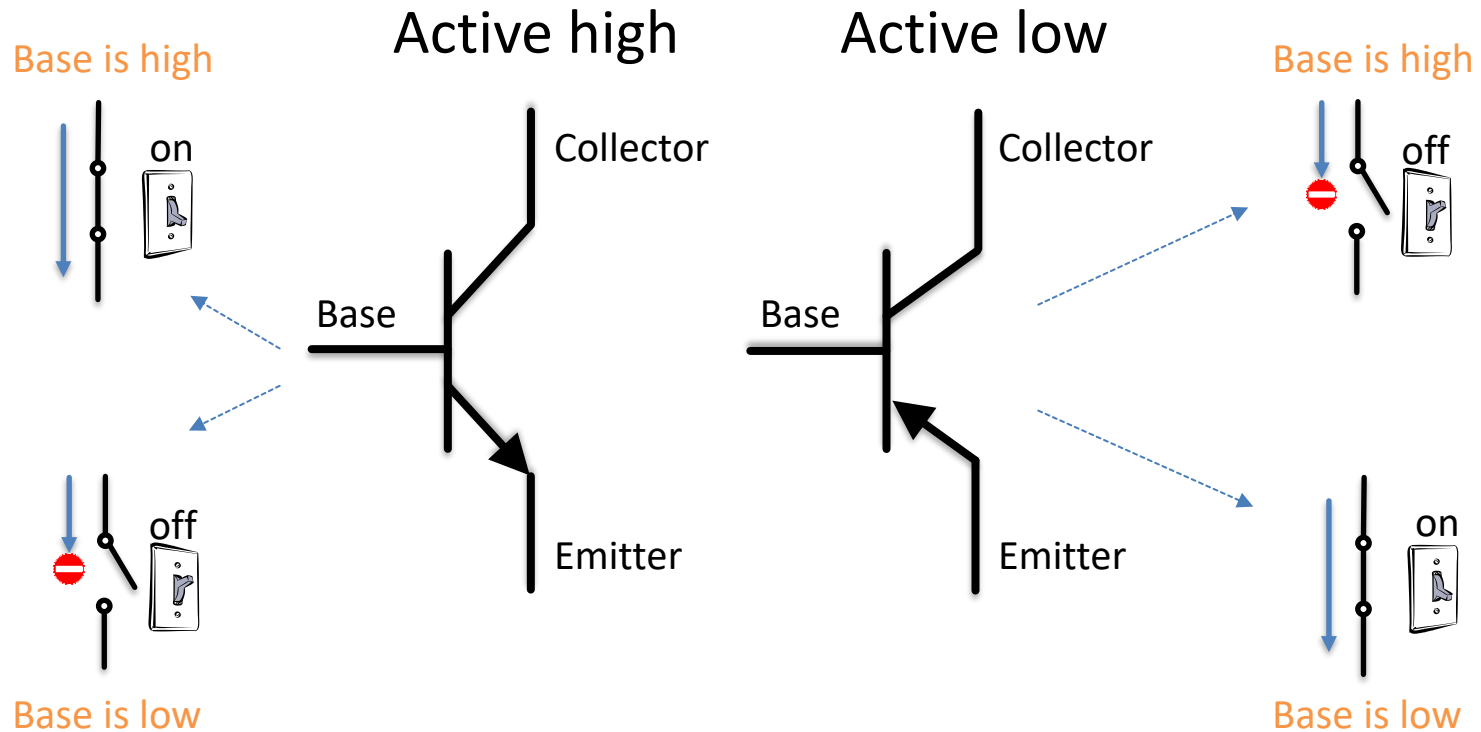

Transistors (3)

- Do we come through?
 - It depends ...
 - Yes, if it is active high and the base is high.
 - No, if it is active high and the base is low.

